IZH35M

.22 LR S/A Pistol INSTRUCTION MANUAL

European American Armory
1426 King Street
Cocoa, FL 32922
www.eaacorp.com
E-mail: eaacorp@eaacorp.com

EAA MODEL: IZH35M

.22 LR S/A Pistol

INSTRUCTION MANUAL

READ THIS MANUAL FOR EAA/BAIKAL IZH35M
BEFORE HANDLING YOUR FIREARM

The IZH35M is a semi-automatic target pistol combining a powerful cartridge, 5 or 8 round magazine capacity, excellent design, anatomical grip, scope mount, and special features for accurate shooting.

CALIBERS: .22 LONG RIFLE FINISHES: BLUE OR CHROME

FOR YOUR SAFETY AND THE SAFETY OF OTHERS, this owner's manual contains important warnings and safety procedures which must be understood BEFORE using this firearm. Read the entire manual and if you do not understand any part it or the operation of your pistol, stop and seek professional firearms instructions. You can get a copy of this manual from European American Armory Corp. on request.

Record the serial number of your firearm:

and a description of it:

Make a copy of this manual, proof of purchase/sales record for safekeeping in a secure safe or fireproof container. Such proof is necessary if the firearm is stolen or for warranty repair.

Specifications of the BAIKAL IZH35M Target Pistol

Trigger: Single Action	Height: 5.5 inches
Caliber: 22LR	Width: 1.75 inches
Length: 10.5 inches	Weight: 45 ounces
Barrel: 6.0 inches	
Magazine Capacity: Full Size 5 or 8 plus 1 cartridges	

WARNING

****YOU RISK INJURY OR DEATH BY HANDLING THIS FIREARM****
BEFORE HANDLING THIS FIREARM, READ, UNDERSTAND AND FOLLOW THE INSTRUCTIONS IN THIS MANUAL. ALWAYS KEEP THIS MANUAL WITH THE FIREARM. IF YOU LEND, GIVE OR SELL THIS FIREARM, BE SURE THE MANUAL GOES WITH IT. IF THERE IS ANYTHING YOU DO NOT UNDERSTAND, SEEK ADVICE FROM SOMEONE QUALIFIED IN SAFE HANDLING OF FIREARMS.

THIS FIREARM IS DESIGNED ONLY FOR TARGET OR COMPETITION AND SHOULD ALWAYS BE TRANSPORTED UNLOADED IN ITS CASE. DO NOT USE THIS FIREARM FOR CARRY, DUTY OR DEFENSIVE PURPOSES.

TYPE OF AMMUNITION TO BE USED

It is suggested that high quality commercially manufactured ammunition be used in this firearm. Other types of ammunition may have feeding or extraction problems. Some factory ammunition works better than others and you should stick with that brand you find works well in your semiautomatic pistol. Avoid military surplus or hot loaded ammo. The use of reloaded, +P, high pressure or hand loaded ammunition will void the warranty.

NOTICE

PISTOLS ARE CLASSIFIED AS FIREARMS OR DANGEROUS WEAPONS and are sold by European American Armory Corporation with the specific understanding that we are not responsible in any manner what-so-ever for their safe handling or resale under local laws and regulations.

European American Armory shall not be responsible in any manner whatsoever for malfunctioning of the firearm, for physical injury or for property damage resulting in whole or in part from (1) intentional or negligent discharge, (2) improper or careless handling, (3) unauthorized modifications, (4) defective, improper, hand-loaded, or reloaded ammunition, (5) corrosion and/or lack of proper maintenance (6) neglect, or (7) other influences beyond our direct and immediate control. This limitation applies regardless of whether liability is asserted on the basis of contract, negligence or strict liability (including any failure to warn). Under no circumstance shall European American Armory Corporation be liable for incidental or consequential damages, such as loss of use of property, commercial loss and loss of earnings or profits.

SAFETY PROCEDURES

1. We recommend that you get competent firearms instruction in safe handling before using this firearm. Please ask your dealer. All guns are extremely dangerous if carelessly handled or used. Remember that the gun user is the primary "safety" and to depend on any mechanical devices is to be only half safe.

EVEN WITH THE MAGAZINE REMOVED, THIS FIREARM WILL STILL FIRE IF A ROUND (LIVE BULLET) IS IN THE CHAMBER AND THE TRIGGER IS PULLED AND THE MANUAL SAFETY IS OFF.

person or anything you do not intend to shoot. Always keep your gun unloaded until ready to use and make sure that it is unloaded before cleaning.

Keep your finger OFF the trigger until you are actually aiming at the target and ready to shoot.

Never rely on a gun's "safety" to protect you from unsafe gun handling. A safety is only a mechanical device, not a substitute for common sense and gun safety procedures.

Never leave a gun unattended or where it could fall and fire.

Store guns and ammunition separately **beyond the reach of children**. Make sure that they are properly secured so untrained individuals and children will be denied access to your guns and ammo.

Test your gun's operation and safeties **ONLY** at a shooting range while the firearm is pointed in a safe direction.

Know your target and what is beyond. Ask yourself what your bullet will hit if it misses the target or passes through the intended target. Remember, a fired bullet can travel over a mile (including a ricochet) and is capable of going through walls.

Guns and alcohol or drugs do not mix. Don't take any alcoholic beverages and/or drugs before or during shooting activities.

Never pull a gun toward you by the muzzle. Don't climb a tree, cross a ditch or fence with a loaded gun.

Always empty guns before entering a house, car, truck, boat, RV, camp or any building.

When receiving a gun, always open the action and check to make sure it is unloaded.

NEVER accept anyone's word that a gun is "unloaded" or "empty". You should immediately open the action and check to make sure it is unloaded.

Be careful with ALL ammunition. Even "blank" cartridges are deadly at close range due to the muzzle blast. Make sure your ammunition is in new and in good clean condition. Do NOT oil or grease ammo as this may damage the cartridge primer. Do NOT tamper with or alter the standard factory ammunition.

Keep firearms unloaded when not actually in use. Load the gun only when on the range preparing to fire and unload it before leaving the range.

Never put your hand over the muzzle of a gun.

ALWAYS WEAR protective shooting glasses and hearing protection when using firearms.

Spectators should be at least 10 feet behind and away from the shooter while the shooter is loading, shooting and unloading. Spectators should wear protection for hearing and sight loss and they should avoid distracting those firing their weapons.

-WARNINGS-

**READING THESE SAFETY RULES WILL
SAVE YOUR LIFE OR THE LIFE OF SOMEONE ELSE**

Never carry a handgun in your pocket, purse or tucked in a belt or waistband. Use a pistol case or a proper holster with safety flap or strap.

Never drop your gun. If you do drop it, unload it and check it for proper function before using it again.

Don't alter or modify your gun. Don't try to change your gun's trigger pull, because it may affect sear engagement and thereby cause accidental firing.

Do not remove any internal safety or safety device on the firearm. Safety mechanisms are designed to protect you from injury or death.

Do maintain and keep your gun clean. Keep in a dry place away from other metals and water. If your gun shows sign of corrosion or improper operation, have it serviced by a competent gunsmith.

Keep the muzzle pointed in a safe direction when loading and unloading your gun. Never point the muzzle at anyone.

Never shoot at hard flat surfaces or water....bullets ricochet.

If a gun fails to fire when the trigger is pulled, keep it pointed down range at the target for 30 seconds. Sometimes slow primer ignition will cause a "hang fire" and the cartridge will go off after a short pause. If it still fails to fire, keep muzzle pointed in safe direction and avoid exposure to the breech, as you attempt to unload your firearm.

When loading a semi-automatic pistol, make sure that the muzzle is pointed in a safe direction and you are not exposed to the breech and the bolt assembly's ejector port or top opening as you release the bolt to travel forward.

Never let water, snow, mud or other material enter the barrel. Always be sure the barrel is free of any obstruction.

Since many ammunition identifications sound similar, be sure that you use only the correct ammunition for your gun. Do NOT use the wrong size or wrong strength ammunition in your firearm.

Repeated and prolonged exposure to gunfire may result in toxic levels of lead in your body. In addition, there are risks of cancer, impotency and birth defects. When shooting indoors, make sure there is proper ventilation.

Teach children: 1. NOT to touch guns, bullets, cartridges, shells or any explosive device and 2. if they discovery such a dangerous item or weapon, they must immediately report its location to their parents, school teacher and police.

Remember a firearm has the capability of taking your life or the life of someone else. Be careful with your firearm -- an accident is almost always the result of not following basic safety rules.

-WARNINGS-

**READING THESE SAFETY RULES WILL
SAVE YOUR LIFE OR THE LIFE OF SOMEONE ELSE**

Never carry a handgun in your pocket, purse or tucked in a belt or waistband. Use a pistol case or a proper holster with safety flap or strap.

Never drop your gun. If you do drop it, unload it and check it for proper function before using it again.

Don't alter or modify your gun. Don't try to change your gun's trigger pull, because it may affect sear engagement and thereby cause accidental firing.

Do not remove any internal safety or safety device on the firearm. Safety mechanisms are designed to protect you from injury or death.

Do maintain and keep your gun clean. Keep in a dry place away from other metals and water. If your gun shows sign of corrosion or improper operation, have it serviced by a competent gunsmith.

Keep the muzzle pointed in a safe direction when loading and unloading your gun. Never point the muzzle at anyone.

Never shoot at hard flat surfaces or water....bullets ricochet.

If a gun fails to fire when the trigger is pulled, keep it pointed down range at the target for 30 seconds. Sometimes slow primer ignition will cause a "hang fire" and the cartridge will go off after a short pause. If it still fails to fire, keep muzzle pointed in safe direction and avoid exposure to the breech, as you attempt to unload your firearm.

When loading a semi-automatic pistol, make sure that the muzzle is pointed in a safe direction and you are not exposed to the breech and the bolt assembly's ejector port or top opening as you release the bolt to travel forward.

Never let water, snow, mud or other material enter the barrel. Always be sure the barrel is free of any obstruction.

Since many ammunition identifications sound similar, be sure that you use only the correct ammunition for your gun. Do NOT use the wrong size or wrong strength ammunition in your firearm.

Repeated and prolonged exposure to gunfire may result in toxic levels of lead in your body. In addition, there are risks of cancer, impotency and birth defects. When shooting indoors, make sure there is proper ventilation.

Teach children: 1. NOT to touch guns, bullets, cartridges, shells or any explosive device and 2. if they discovery such a dangerous item or weapon, they must immediately report its location to their parents, school teacher and police.

Remember a firearm has the capability of taking your life or the life of someone else. Be careful with your firearm -- an accident is almost always the result of not following basic safety rules.

-WARNINGS-
READING THESE SAFETY RULES WILL
SAVE YOUR LIFE OR THE LIFE OF SOMEONE ELSE

HOME SAFETY IS PROBABLY YOUR BIGGEST CONCERN. We suggest the following gun lock: Master Gun Lock. It works on most Firearms and is available in gun shops and sporting goods departments. For more information write: Master Gun Locks; Master Lock Company, P.O. Box 10367, Milwaukee, WI. 53210. After all you have invested this much in your new gun, now invest a little more in your family's safety.

USED FIREARMS - If you got your European American Armory firearm as a used gun, BEFORE USING IT you should unload it and check all its functions to be sure it works correctly. Firearms are some times altered to work incorrectly, or parts may be removed, lost or replaced with incorrect parts. First, unload it and check it yourself and then take it to a good gunsmith who knows European American Armory Baikal firearms, and have him examine it.

WRITE US concerning any items or circumstances which you don't understand and which might relate to your safety and the operation of your firearm.

WARNING

ANY BORE OBSTRUCTION, EVEN IF IT IS ONLY PARTLY BLOCKED, MAY CAUSE THE GUN TO BLOW UP IF IT IS FIRED, OR MAY CAUSE DAMAGE TO THE GUN SUCH AS A BULGED BARREL. TO AVOID INJURY OR DEATH TO THE SHOOTER OR BYSTANDERS, CHECK THE BARREL BEFORE SHOOTING OR IF A SHOT DOES NOT SOUND NORMAL.

EXTERNAL CONTROL PARTS

DO NOT LOAD THIS PISTOL UNTIL YOU UNDERSTAND THE SAFETIES AND HOW THIS PISTOL OPERATES.

Manual Safety Lever: Located on the left hand side of the pistol in the rear next to the rear sight. This safety disconnects the trigger bar when engaged (safety lever is rotated down or parallel to the slide to disconnect the trigger bar,). To fire, rotate the safety lever to the up position. KEEP this pistol "on safe" except at the actual moment of firing, to help protect against accidental firing and possible injury or death of yourself or others. (See Fig: 1a)

Grip Safety: Located in the rear of the grip below the rear sight on the right hand side of the metal portion of the grip. This safety blocks the sear. This safety must be depressed for the pistol to fire. (See Fig: 2)

Cocking Indicator: located on top of the gun in front

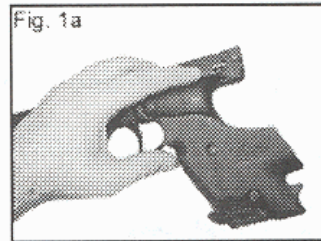

of the rear sight. A red dot showing indicates that the pistol is cocked. (See Fig: 3)

Scope Mount: Included in the box. The top of the sight plane is drilled and tapped for the mount. We suggest you use some type of locking/antivibration adhesive on the scope mount screws so they do not vibrate loose during use. (See Fig: 4)

Adjustable Grip: Right hand only, a flat head screw is used to lock vertical adjustment of grip. (See Fig: 5)

Bolt Hold Back: Located on right hand side of the frame lever type. Slide bolt to the rear and then lift up Bolt Hold Back so that it engages the notch in the slide and holds the bolt in the rearward position. (See Fig: 6)

Adjustable Rear Sight: Located at the rear of the gun above the grip. The screw on the right hand side of the sight adjust for windage, clock wise turning will move the rear blade to the right side. The screw in the center of the sight on the top adjusts elevation, clockwise turning moves the rear blade up. (See Fig: 7a & 7b)

Trigger: Has three adjustments. The screw in the trigger adjust fore and aft location of the trigger. The forward screw located on the trigger base adjust trigger over travel and the aft screw located on the trigger base adjust trigger take up. (See Fig: 8a, 8b, 8c)

Magazine Release Button: Button type push to release magazine located on left hand side of grip on lower portion of grip. (See Fig: 9)

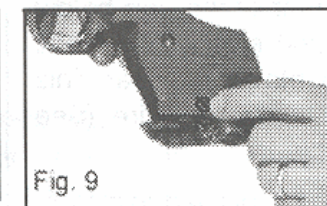
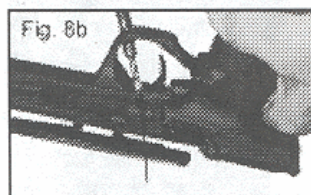
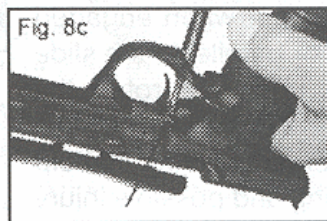
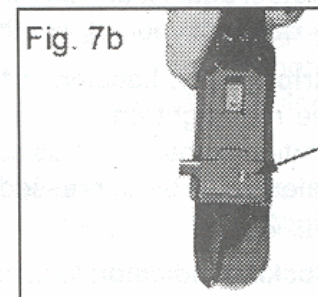
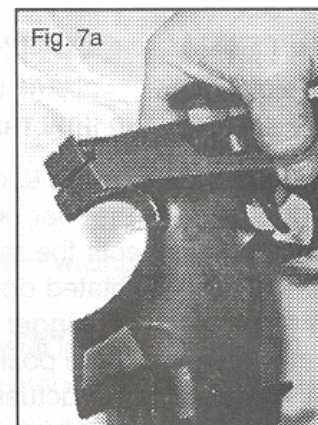
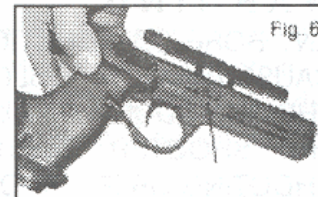
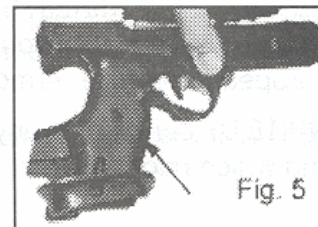
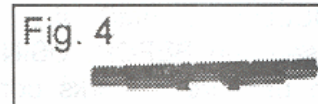
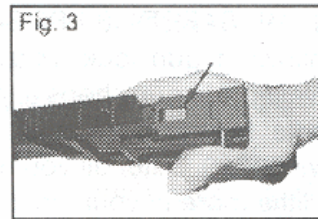

LOADING INSTRUCTIONS

1. Always use original high quality commercially manufactured ammunition in good condition. Hollow point ammo can sometimes cause feeding problems in semi-automatic pistols. If you find one brand that works well, stick with it. Avoid the use of military surplus, reloaded, or hot loaded ammo. European American Armory Corp. assumes no responsibility for incidents which occur through the use of cartridges of non-standard dimension or those developing excessive pressures.

2. Before loading be sure the pistol is fully unloaded (See Unloading Instructions) and the MANUAL SAFETY LEVER IS ON or down.

3. Depress the magazine release button on the left lower side of the grip and remove the magazine.

4. Load the magazine with cartridges by pushing the cartridge down and sliding it rearward with your thumb. (See Fig: 10)

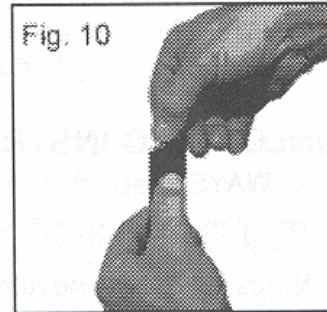

5. Insert the magazine in the receiver until the magazine catch secures it in the receiver with a click. Avoid slamming the magazine into the pistol. Handle the magazine carefully when loading. Any damage by dropping may bend the magazine lips which can cause mis-feeding.

6. To load the chamber, first be sure your fingers are out of the trigger guard, the gun is pointed in a safe direction and you are wearing eye & hearing protection. Holding the pistol grip, grasp the serrations on the guide lugs of the bolt assembly with your other hand and pull the bolt assembly rearward until it cannot travel any further. Release the bolt and allow it to go forward into the closed position. As the bolt assembly travels forward, it will automatically strip a cartridge from the magazine lips and insert it into the firing chamber.

WARNING Face away as bolt closes and never force the bolt assembly closed.

WARNING Your pistol is now loaded and ready to fire. IMMEDIATELY MAKE SURE THE SAFETY LEVER IS DOWN OR IN THE SAFE POSITION. At this point the safety is on and the gun is cocked, the cocking indicator red dot is exposed at this point. (See Fig: 11a)

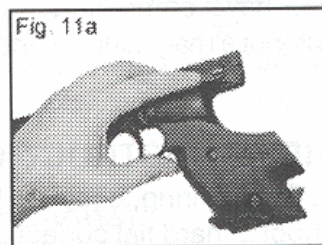

7. IF YOU DO NOT WISH TO FIRE THE PISTOL AFTER LOADING, UNLOAD IT IMMEDIATELY. See Unloading Instructions. NEVER CARRY, HANDLE, OR CLEAN THIS PISTOL WITH A LOADED CARTRIDGE IN THE CHAMBER. EVEN WITH THE MAGAZINE REMOVED, THIS FIREARM WILL STILL FIRE IF A ROUND IS IN THE CHAMBER AND THE TRIGGER IS PULLED AND THE SAFETY IS DISENGAGED.

WARNING

Always keep the muzzle pointed in a safe direction! Never attempt to load or unload any firearm inside a vehicle, building or other confined space (except a properly constructed shooting range). Enclosed areas frequently offer no completely safe direction in which to point the firearm. If an accidental discharge occurs, there is great risk of injury or property damage. Before loading, always clean all, grease and oil from the bore and chamber, and check to be certain that no obstruction is in the barrel. Any foreign matter in the barrel could result in a bulged or burst barrel or other damage to the firearm and could cause serious injury to the shooter or to others.

UNLOADING INSTRUCTIONS

1. ALWAYS keep your firearm pointed in a SAFE DIRECTION.
2. BE SURE THE SAFETY LEVER IS ON SAFE or down.
3. Press the magazine release button and remove the magazine from the pistol. WARNING removal of the magazine does NOT prevent this pistol from firing. If a bullet or round is in the firing chamber, that round can still be fired.
4. Unload the firing chamber by keeping the pistol pointed in a safe direction, keep your finger(s) outside of the trigger guard and off the trigger.
5. Pull the bolt assembly (gripping the serrations) to the rear so that the extractor can pull out the cartridge in the chamber. Lock the bolt to the rear with the Bolt Hold Back Latch / Lock. Visually check to be sure that the chamber is completely empty and the cartridge has completely exited the firearm. The barrel may be checked by passing a cleaning rod through it. (See Fig: 12)

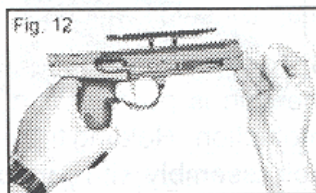

WARNING

When you remove the magazine always double check the chamber to insure you have completely unloaded this firearm. Since the trigger will operate without a magazine inserted, make sure that the safety lever is ON SAFE or down.

FIRING INSTRUCTIONS

1. Before firing, check to be sure you have a safe target and backstop. Never shoot at hard flat surfaces, rocks, water or anything that might make the bullet ricochet. Think about what you will hit if you miss the target. Put on your eye and hearing protection.
2. Load the magazine and chamber as discussed in the Loading Instructions. Keep the gun pointed toward the target.
3. Push the Safety Lever UP into the FIRE position only when you are ready to fire.
4. Grasp the pistol by the grip and keep it forward away from the body. Never place your hand in front of the barrel at any time. Take aim by placing the front

sight post exactly between the two rear sight posts and they are horizontally in line. Carefully align the front sight and rear sight so that the top surfaces mate at the lower or 6 o'clock position of the black portion of the target. **Note: Make sure that when you are holding the grip that you are depressing**

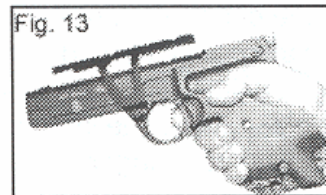

the grip safety. If the grip safety is not fully depressed the gun will not fire. Squeeze the trigger and the gun will fire. After the first shot, the hammer will automatically cock for successive firing and the hammer will be indicated as cocked by the cocking indicator. A gentle squeeze of the trigger is all that is necessary for successive firing and is best for accuracy.(See Fig: 13)

5. The pistol will fire one shot with every squeeze of the trigger until the magazine is empty. When the guns stops firing, take your finger off the trigger and rotate the Safety Lever down to the SAFE position. Remove the magazine, slide the bolt back and lock it in the open bolt position with the Bolt Hold Back Lock. Check the chamber to make sure it is empty and then repeat loading and firing instructions as desired.

If you want to stop firing, immediately turn the safety lever down in order to put the pistol on safe. Unload the firearm as stated in Unloading Instructions.

WARNING

If there is any reason to suspect that a bullet or projectile is obstructing the barrel, immediately unload the firearm (See Unloading Instructions) and check the firing chamber and the bore. It is not sufficient to merely retract the bolt and look at the rear of the barrel (firing chamber). A bullet may be lodged some distance down the barrel where it can not easily be seen. Check the bore by using a cleaning rod to pass through the barrel. If a bullet is in the bore, **DO NOT ATTEMPT TO SHOOT IT OUT WITH ANOTHER CARTRIDGE, OR BLOW IT OUT WITH A BLANK CARTRIDGE OR A CARTRIDGE FROM WHICH THE BULLET HAS BEEN REMOVED. SUCH TECHNIQUE(S) CAN GENERATE EXCESSIVE PRESSURE, DAMAGE THE FIREARM AND CAUSE SERIOUS PERSONAL INJURY.** If the bullet can be removed with a cleaning rod, clean any unburned powder grains from the bore, chamber & mechanism before resuming shooting. If the bullet can not be dislodged by tapping it with a cleaning rod, take the firearm to a gunsmith.

WARNING (Mechanical Malfunctions)

STOP SHOOTING IMMEDIATELY AND UNLOAD YOUR FIREARM if your firearm develops: a mechanical malfunction; binding or stoppage; spitting powder/gas; a cartridge primer is punctured; a cartridge case is bulged or ruptured; or the sound on firing does not sound quite right. Do NOT try one more shot but unload your firearm and take it and the ammunition to a gunsmith for examination. Do not assume that the pistol is empty merely because the bolt remains open. An unfired cartridge or a fired cartridge case jammed between the bolt and the barrel can prevent the bolt from closing. Always look

in the chamber to make sure! Should a jam occur, clear it as follows: 1. point the muzzle in a safe direction, engage the safety and remove the magazine; 2. Pull back the bolt and lock it to the rear by engaging the Bolt Hold Back Lever and 3. remove the jammed cartridge or case by shaking the pistol or picking it out with your fingers.

DISASSEMBLY OR FIELD STRIPPING INSTRUCTIONS

1. Unload the pistol. (See the Unloading Instructions). **CAUTION:** Simply removing the magazine, does NOT unload the chamber. If a cartridge is still in the chamber, the pistol can FIRE even with the magazine removed. Keep the barrel of the gun pointed away from you during any field stripping operations.

2. With the pistol completely unloaded, remove the grip by unscrewing the grip screws on both sides of the grip. With the grip screws completely removed, the grip can be removed from the frame. (See Fig: 14)

3. Remove the lower barrel shroud by depressing the lower barrel shroud detent and sliding the shroud down and forward and away from the frame. (See Fig: 15)

4. Slide the bolt to the rearward position and hold it in the rearward position. (See Fig: 16)

5. Remove the upper barrel shroud by unscrewing shroud screws and then by pushing the shroud to the rear of the pistol and pushing the rear of the shroud in a downward movement. The front of the shroud should move up and then you should be able to remove the shroud in an upward and outward motion. (See Fig: 17)

6. Allow the bolt to move to its forward position and then move the forward end of the bolt down so that it clears the front barrel block. Be careful the bolt is under spring tension and once it clears the barrel block can fly away from the gun with considerable force. (See Fig: 18)

7. Disassembly to this point is sufficient for normal maintenance of this pistol and any further disassembly should only be done by a qualified gunsmith.

8. DO NOT disassemble the pistol any further or attempt to modify the internal workings of this pistol. It is made of precision built components, assembled & tested to rigid specifications. Erroneous re-assembly, modification or alteration is extremely hazardous and dangerous and will void the repair warranty of European American Armory Corporation.

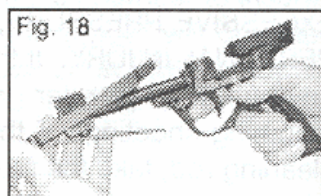
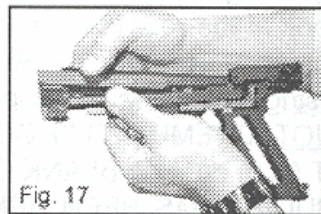
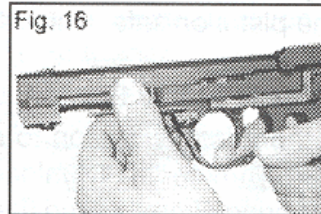
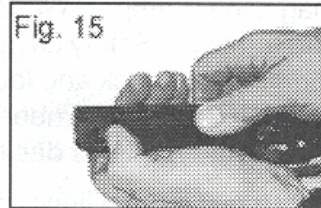
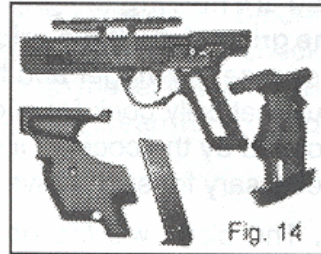

ASSEMBLING THE PISTOL

1. Reinstall the bolt and the recoil spring and guide. Be careful when you reinstall the bolt because the recoil spring is under tension. Note: you must make sure the recoil spring slides around the recoil guide rod during bolt reassembly. The bolt will go back into the frame with the back end in first at an angle required to bypass the front barrel block. (See Fig: 19)

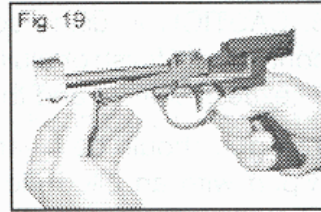

2. Reinstall the upper barrel shroud by sliding the bolt back and then inserting the end of the upper barrel shroud that is not relieved for the front sight into the area in front of the rear sight on top of the barrel. The shroud will go in at an angle and then lock down in a parallel axis to the barrel. Once the shroud is in place, release the bolt so that it moves to its home position. (See Fig: 20)

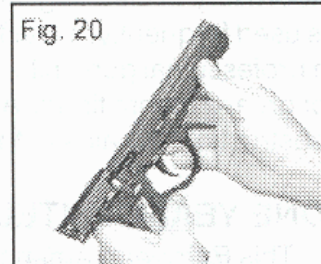

3. Reinstall the lower barrel shroud by installing the back end first at an angle to allow the front of the shroud to pass the barrel block. Then move the shroud back until it is parallel with the barrel and then move it forward until it enters the rails and locks in place with the lower barrel shroud detent. (See Fig: 21)

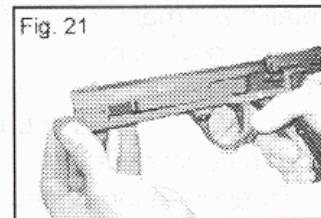

4. Check all pistol functions with the pistol totally empty including: manual safety, grip safety, bolt hold back, grip fit, etc.

CLEANING AND MAINTENANCE OF PISTOL

1. Materials needed to clean this pistol are a pistol cleaning rod, cotton bore patches, brass bore brush, powder solvent, a small soft brush and good quality gun oil.

2. Disassemble (field strip) the pistol as discussed in this instruction manual.

WARNING: Lead or lead compounds are known to the State of California to cause cancer, birth defects and/or reproductive toxicity. Those who clean firearms should take protective measures to avoid contact or exposure to such chemicals.

3. Using the bore brush with powder solvent scrub the barrel and chamber to remove any powder and lead residue in the bore. Secondly, swab the bore with cotton patches soaked in solvent. Always and lastly, swab with cotton patch with gun oil to coat and protect the bore from rust and corrosion.

4. Any powder fowling on the receiver or breech face of the bolt can be easily cleaned with a brush and powder solvent.

5. All external surfaces should be wiped down with light coat of rust preventative. Avoid using too much oil as dust and/or debris can get trapped in the oil creating a gum that in time will cause misfires.

6. CAUTION in using solvents in gun bore cleaning. Prolonged or excess contact with finish or bluing can damage the gun's finish. Be sure to wipe away all excess solvent and then lubricate with oil.

7. A gun should be cleaned after firing. In addition, external parts should be wiped with an oiled cloth after handling. A light oil is ordinarily all that is necessary in cleaning if the gun has not been fired or fired very little. If a gun is used frequently, it must be cleaned after each firing and regularly serviced by a professional gunsmith. If the gun has been stored, remove all excess oil and/or grease before firing. Always check to be sure that no cleaning patch or other obstruction remains in the bore or chamber before firing.

ONE YEAR LIMITED WARRANTY

This European American Armory Corp. firearms is warranted to the original retail customer for One Year from date of purchase against defects in material and workmanship. All parts and labor or replacement **at our option** are covered. Wood Grips are not covered by the One Year Warranty. The warranty on the Wood Grips is 60 days from purchase and only covers manufactured and material defects.

Transportation to and from our repair facilities, government fees, damage caused by failure to perform normal maintenance, sales outside the United States, damage due to use of high velocity, high pressure, reloaded or other nonstandard ammunition, or any unauthorized repair, modification, misuse, abuse, or alteration of the product is not covered by this Limited Warranty.

Any implied warranties, including the implied warranties of merchantability and fitness for a particular purpose, are limited to one year from date of original retail purchase. Consequential or incidental damages and/or expenses, or any other expenses are not covered by this warranty.

To obtain warranty performance send your firearm with proof of retail purchase, freight prepaid to:

European American Armory
1426 King Street
Cocoa, FL 32922

WARNING

Altering or modifying parts and/or safeties is dangerous and will void the warranty. This recoil operated semi-automatic pistol was manufactured to perform properly with the original parts as designed. It is your duty to make sure any parts you buy are made for this firearm and are installed correctly and that neither the replacements nor originals are altered or changed. Your gun is a complex precision tool with many parts that must relate correctly to other parts in order for proper and safe operation. Putting a gun together wrong or with incorrect or modified parts can result in a damaged gun, danger, and injury or death to you and others through malfunction. Always have a qualified gunsmith work on your gun or at least check any work not performed by a gunsmith.

ALL PARTS ORDERS ARE SUBJECT TO A \$10.00 CHARGE FOR SHIPPING AND HANDLING. Please state Model, Caliber, Serial Number, and Finish Color when ordering. For parts and service contact:

European American Armory 1426 King Street, Cocoa, FL 32922
(321) 639-4842

PARTS LIST

Fig. 1 - IZH35M Exploded View

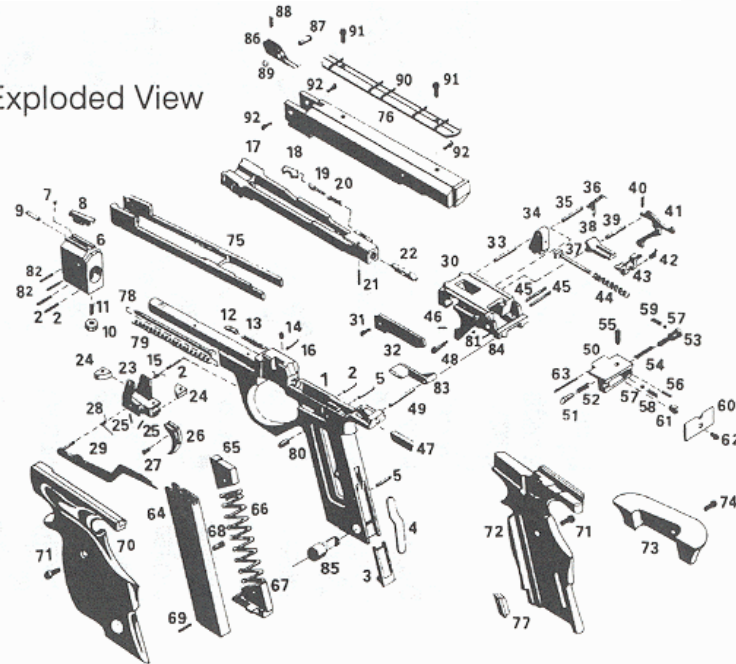

- | | | |
|----------------------------------|-------------------------------|-------------------------------|
| 1. Pistol frame | 32. Cover | 63. Pivot |
| 2. Trigger base pin | 33. Hammer pivot | 64. Magazine body |
| 3. Magazine catch | 34. Hammer | 65. Follower |
| 4. Catch spring | 35. Pin | 66. Magazine spring |
| 5. Pin | 36. First sear spring | 67. Magazine cover |
| 6. Front sight base | 37. Firing spring guide | 68. Button |
| 7. Plug | 38. First sear | 69. Pin |
| 8. Front sight | 39. First sear pivot | 70. Left grip sideplate |
| 9. Front sight screw | 40. Grip safety spring | 71. Sideplate screw |
| 10. Lower barrel shroud detent | 41. Grip safety | 72. Right grip sideplate |
| 11. Detent spring | 42. Second sear spring | 73. Palm support |
| 12. Plunger | 43. Second sear | 74. Palm support screw |
| 13. Plunger spring | 44. Firing spring | 75. Lower barrel shroud |
| 14. Trigger pull adjusting screw | 45. Pivot | 76. Upper barrel shroud |
| 15. Trigger base spring | 46. Screw | 77. Palm support slideblock |
| 16. Pin | 47. Ejector | 78. Recoil spring guide |
| 17. Bolt | 48. Base screw | 79. Recoil spring |
| 18. Extractor | 49. Pin | 80. Frame plug |
| 19. Extractor plunger | 50. Rear sight base | 81. Base plug |
| 20. Extractor spring | 51. Rear sight base plunger | 82. Pin |
| 21. Pin | 52. Plunger spring | 83. Manual safety lever |
| 22. Firing pin | 53. Windage adjusting screw | 84. Pin |
| 23. Trigger base | 54. Rear sight spring | 85. Magazine release button |
| 24. Plug | 55. Elevation adjusting screw | 86. Bolt hold back latch/lock |
| 25. Adjusting screw | 56. Pin | 87. Latch pivot |
| 26. Trigger | 57. Ball | 88. Latch spring |
| 27. Trigger screw | 58. Ball spring | 89. Washer |
| 28. Trigger bar spring | 59. Ball spring | 90. Scope mount |
| 29. Trigger bar | 60. Rear sight | 91. Scope mount screw |
| 30. Base | 61. Rear sight slideblock | 92. Upper shroud screw |
| 31. Cover screw | 62. Rear sight screw | |